

型号

EQ-2509

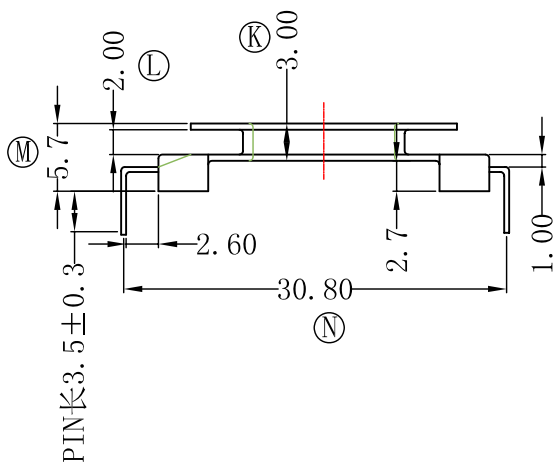
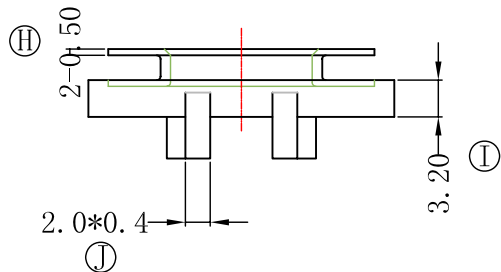
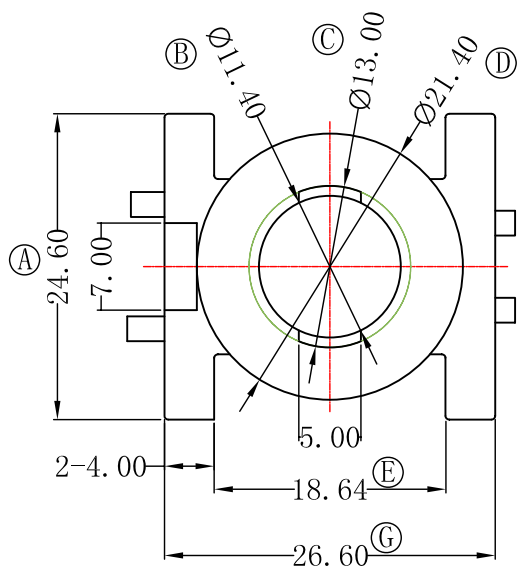

型号

EQ-2509-1

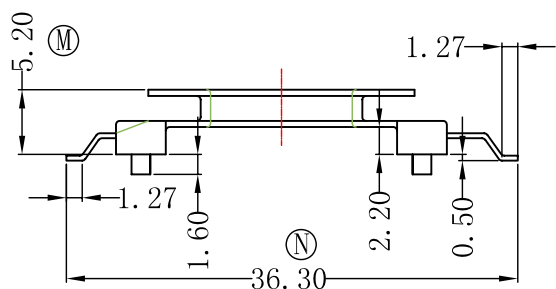

型号

EQ-2509-2

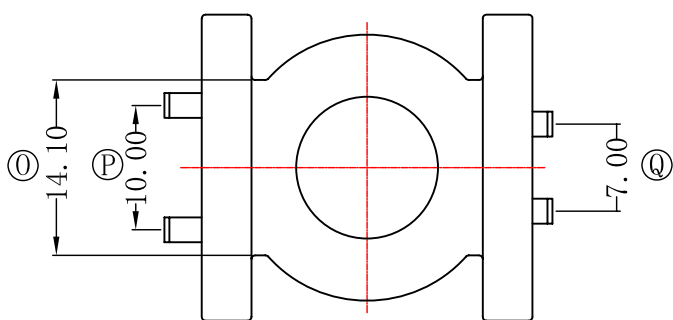
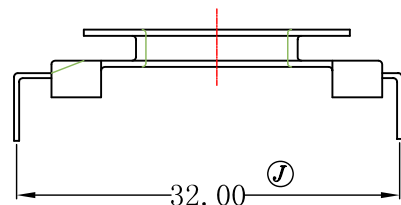

深圳市捷达成电子有限公司

SHENZHEN JIE DA CHENG ELECTRONICS CO.,LTD.

TEL:0755-27317730 FAX:0755-27317731

ANGLE:
+/-1°

UNIT:
MM

SCALE:
4/1

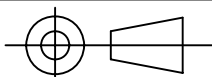

MODEL NAME:
EQ-2509 2+2PIN

UL REC:
UL 94V-0

PIN TENSION LOAD:
1.0KG MIN

DATE:
2012-12-25

BOBBIN MATERIAL:
PM-9820

PIN MATERIAL:
CP WIRE

DRAWING NO:
EQ-2509

REV:
1.0

DRAFTER L.R.J

CHECKER Y.F.

TOLERANCE

0<L<4 ±0.1
4<L<16 ±0.2
16<L<50 ±0.3
PIN PITCH ±0.2