

型号

EFD-3308

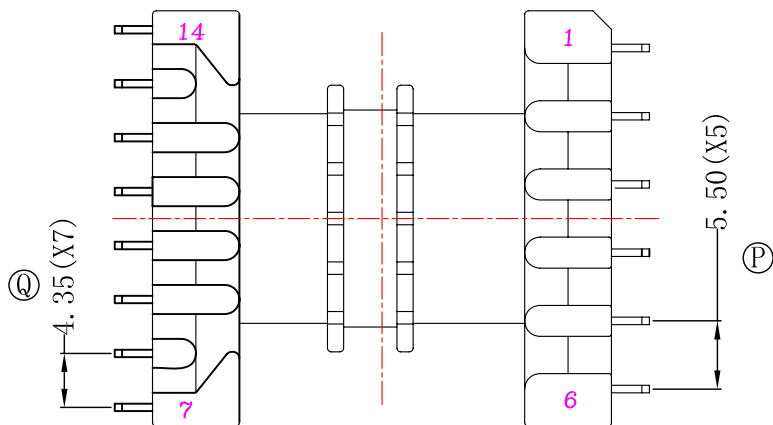
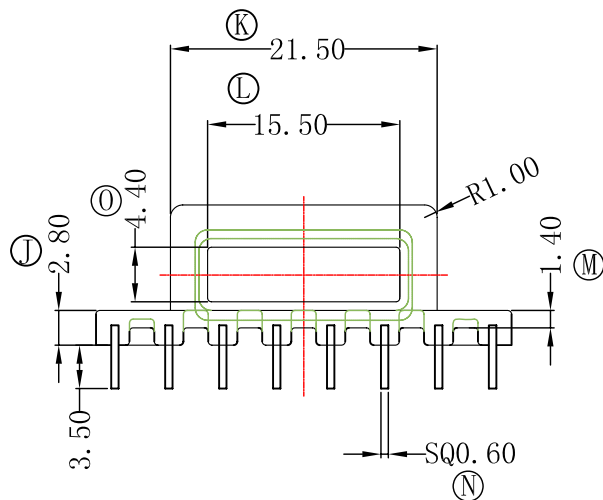
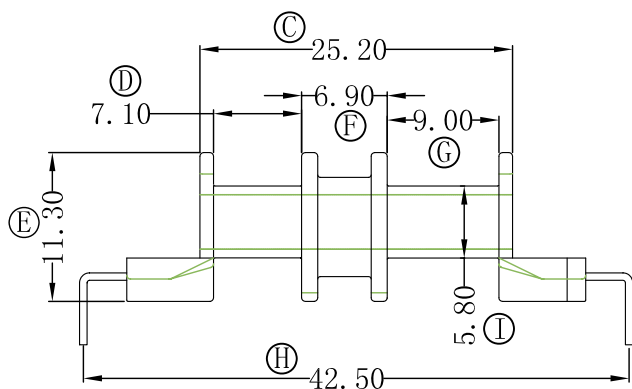
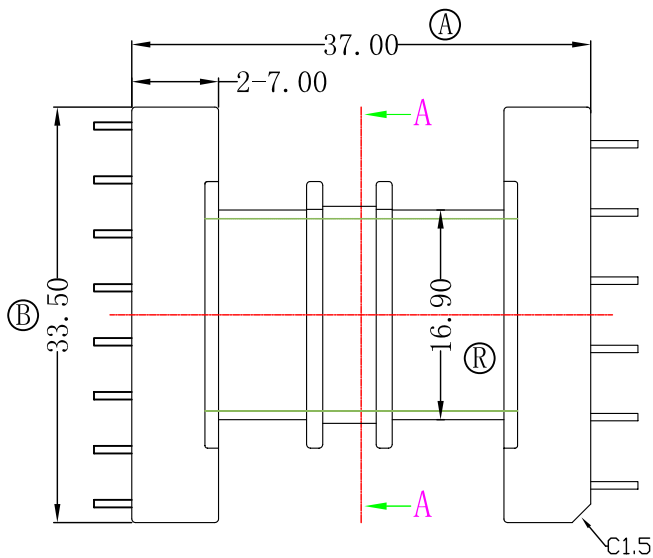

REV	DATE	REVISIONS REC

深圳市捷达成电子有限公司

SHENZHEN JIE DA CHENG ELECTRONICS CO.,LTD.  
TEL:0755-27317730 FAX:0755-27317731

ANGLE:  
+/-1°

UNIT:  
MM

SCALE:  
4/1

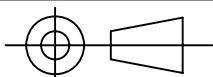

MODEL NAME:  
EFD-3308 6+8PIN

UL REC:  
UL 94V-0

PIN TENSION LOAD:  
1.5KG MIN

DATE:  
2014-12-25

BOBBIN MATERIAL:  
PM-9820

PIN MATERIAL:  
CP WIRE

DRAWING NO:  
EFD-3308

REV:  
1.0

DRAFTER

L.R.J

CHECKER

Y.F.

TOLERANCE

0<L<4 ±0.1  
4<L<16 ±0.2  
16<L<50 ±0.3  
PIN PITCH ±0.2