

型号

ATQ-1807

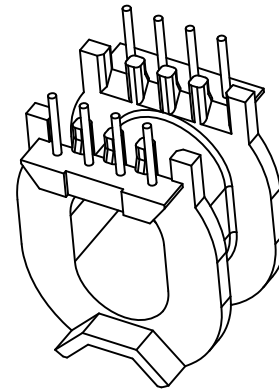
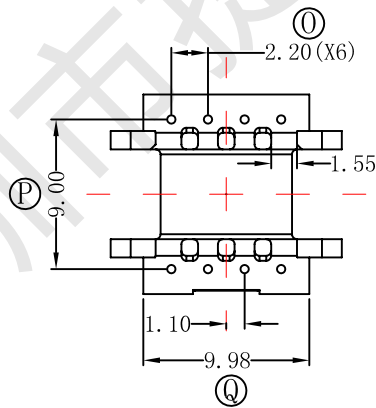
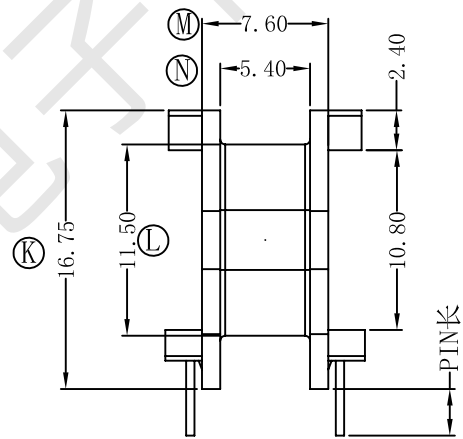
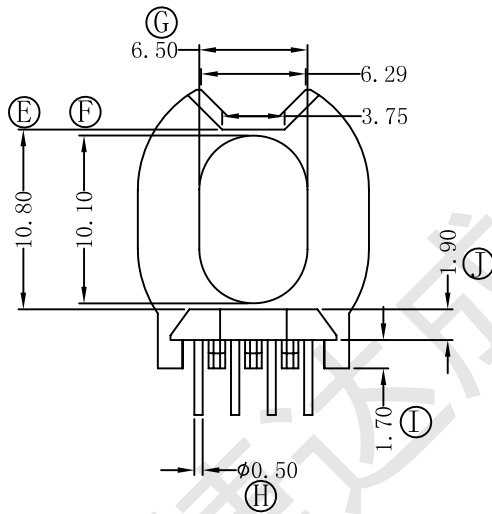
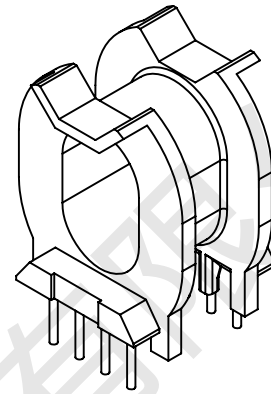
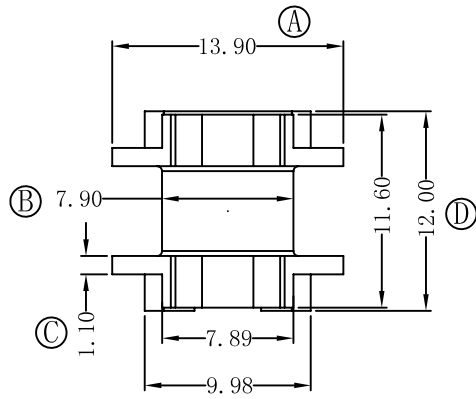

- 1: 进胶口内凹0.2
- 2: 两边对称, 针位不分方向

REV	DATE	REVISIONS REC

深圳市捷达成电子有限公司

SHANZHEN JIEDACHENG ELECTRONICS CO.,LTD.

TEL:0755-27317730 FAX:0755-27317731

ANGLE:
+/-1°

MODEL NAME:
ATQ-1807 4+4PIN

UNIT:
MM

UL REC:
UL 94V-0

BOBBIN MATERIAL:
PM-9823

SCALE:
4/1

PIN TENSION LOAD:
1.0KG MIN

PIN MATERIAL:
CP WIRE

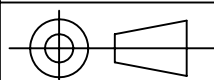

DATE:
2022-12-28

DRAWING NO:
ATQ-18

REV:
1.0

DRAFTER L.R.J

TOLERANCE
0<L<4 ±0.1
4<L<16 ±0.2
16<L<50 ±0.3
PIN PITCH ±0.2

CHECKER Y.F.