

型号

ATQ-1705

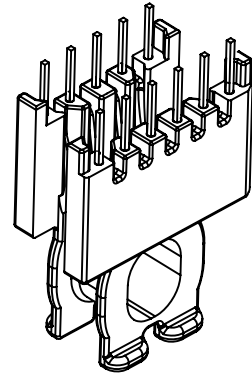
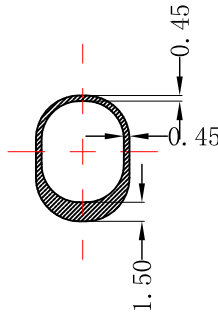
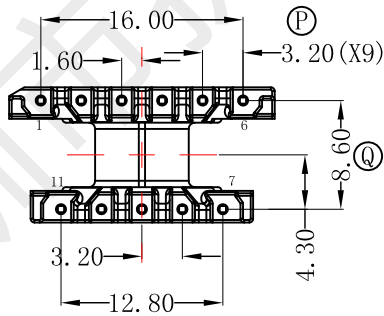
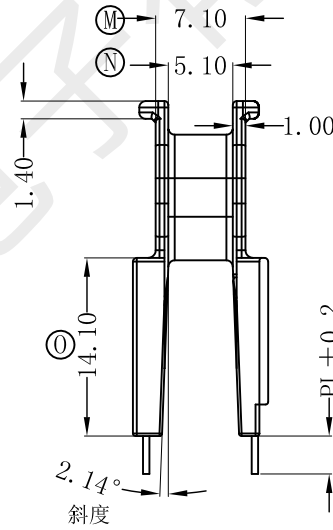
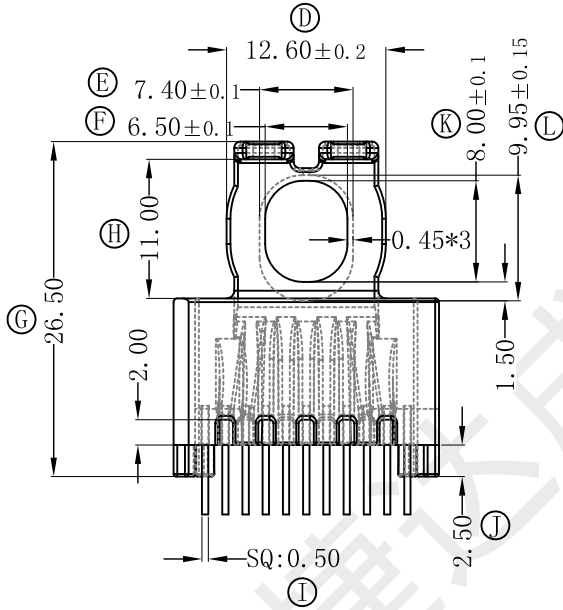
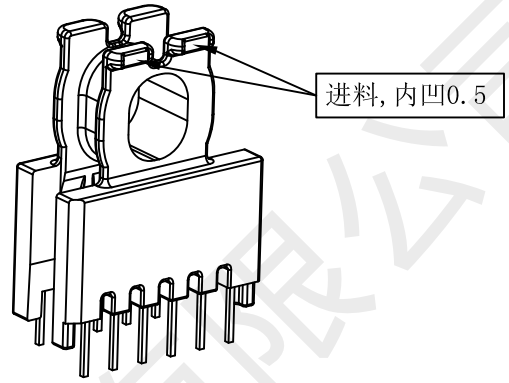
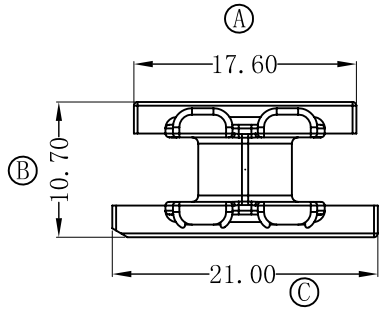

REV	DATE	REVISIONS REC

深圳市捷达成电子有限公司

SHANZHEN JIEDACHENG ELECTRONICS CO.,LTD.

TEL:0755-27317730 FAX:0755-27317731

ANGLE:
+/-1°

UNIT:
MM

SCALE:
4/1

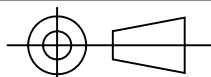

MODEL NAME:
ATQ-1705 6+5PIN

UL REC:
UL 94V-0

PIN TENSION LOAD:
1.0KG MIN

DATE:
2023-05-19

BOBBIN MATERIAL:
PM-9630

PIN MATERIAL:
CP WIRE

DRAWING NO:
ATQ-17

REV:
1.0

DRAFTER

L.R.J

TOLERANCE

0<L<4 ±0.1

4<L<16 ±0.2

16<L<50 ±0.3

PIN PITCH ±0.2

CHECKER

Y.F.